



# HITANO ENTERPRISE CORP.

7F-7, No. 3, Wu Chuan 1st Road, New Taipei  
Industrial Park, New Taipei City, TAIWAN, R.O.C.  
Tel: +886 2 2299 1331 Fax: +886 2 2298 2466

## Data Sheet

Customer : \_\_\_\_\_

Product : Insulated Gate Bipolar Transistor (IGBT) \_\_\_\_\_

Type : H30G3U60SC \_\_\_\_\_

Issued Date: 08-Jan.-2024 \_\_\_\_\_

Edition : Ver. 2 \_\_\_\_\_

### Record of change

Date	Ver.	Description	Page
06-Sep.-2023	1		
08-Jan.-2024	2	Revise Cies_Coes_Cres Unit: pF	2

#### VENDOR :

HITANO ENTERPRISE CORP.

7F-7,NO.3,WUCHUAN1ST ROAD,  
NEW TAIPEI INDUSTRIAL PARK,  
NEW TAIPEI CITY, TAIWAN, R.O.C.  
TEL:+886222991331(REP.)  
FAX:+886222982466



#### MAKER :

Changzhou Starsea Electronics Co., Ltd.

No. 1, Tianmuhu Road, Xinbei District, Changzhou, Jiangsu  
Hot Online : 86-519-85111098  
Mobile : 13915082769 (Mr Zuo)  
Fax : +86-519-85112846





**FEATURES**

- Low switching losses
- $V_{CE(sat)}$  with positive temperature coefficient
- Fast switching and short tail current
- Free wheeling diodes with fast and soft reverse recovery
- Pb-free Lead Plating
- Halogen-free and RoHS-compliant

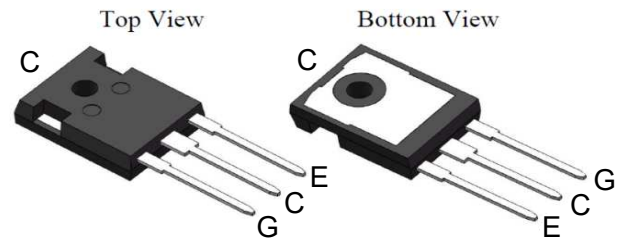

**TO-247-3L**

**MECHANICAL DATA**

Case:TO-247-3L molded plastic body  
 Terminals : Leads solderable per MIL-STD-750,  
 Method 2026  
 Polarity: As marked  
 Mounting Position: Any

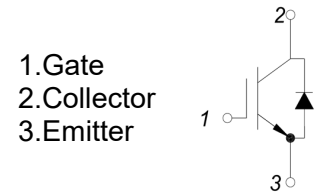

**MAXIMUM RATINGS AND ELECTRICAL CHARACTERISTICS**

**Absolute Maximum Ratings** (@  $T_C = 25^\circ\text{C}$  unless otherwise specified)

Symbol	Parameter/Test Conditions	Values	Unit
$V_{CES}$	Collector Emitter Voltage	$T_J = 25^\circ\text{C}$	V
$V_{GES}$	Gate Emitter Voltage	$\pm 20$	
$I_C$	DC Collector Current	$T_C = 25^\circ\text{C}$	A
		$T_C = 100^\circ\text{C}$	
$I_{Cpuls}$	Pulsed collector current, tp limited by $T_{Jmax}$	90	
$P_{tot}$	Power Dissipation Per IGBT	$T_C = 25^\circ\text{C}$	W
		$T_C = 100^\circ\text{C}$	
$V_{RRM}$	Repetitive Reverse Voltage	$T_J = 25^\circ\text{C}$	V
$I_F$	Average Forward Current	$T_C = 25^\circ\text{C}$	A
		$T_C = 100^\circ\text{C}$	
$T_{Jmax}$	Max. Junction Temperature	150	$^\circ\text{C}$
$T_{Jop}$	Operating Temperature	-40~150	
$T_{stg}$	Storage Temperature	-55~150	

**Thermal Resistance**

Parameter	Symbol	Conditions	Value			Unit
			min.	typ.	max.	
<b><math>R_{th}</math> Characteristics</b>						
IGBT thermal resistance, junction - case( IGBT )	$R_{th(j-c)}$		-	-	0.80	$^\circ\text{C}/\text{W}$
Diode thermal resistance, junction - case( per diode )	$R_{th(j-c)}$		-	-	1.43	$^\circ\text{C}/\text{W}$
Thermal resistance junction - ambient	$R_{th(j-a)}$		-	-	43	$^\circ\text{C}/\text{W}$

IGBT

**Electrical Characteristic (at TC = 25 °C, unless otherwise specified)**

Symbol	Parameter/Test Conditions		Min.	Typ.	Max.	Unit	
$V_{GE(th)}$	Gate Emitter Threshold Voltage	$V_{CE}=V_{GE}, I_C=1mA$	3.5	5.4	7.0	V	
$V_{CE(sat)}$	Collector Emitter Saturation Voltage	$I_C=30A, V_{GE}=15V, T_J=25^\circ C$		1.75	2.40		
$I_{CES}$	Collector Leakage Current	$V_{CE}=600V, V_{GE}=0V, T_J=25^\circ C$			1.0	mA	
$I_{GES}$	Gate Leakage Current	$V_{CE}=0V, V_{GE}=\pm 20V, T_J=25^\circ C$	-250		250	nA	
$Q_g$	Total Gate Charge	$V_{CE}=400V, I_C=30A, V_{GE}=15V$		162		nC	
$Q_{ge}$	Gate emitter charge			33.5			
$Q_{gc}$	Gate collector charge			73.2			
$t_{d(on)}$	Turn on Delay Time	$V_{CE}=400V, I_C=30A$ $R_G=10\Omega,$ $V_{GE}=15V,$ Inductive Load	$T_J=25^\circ C$	65		ns	
$t_r$	Rise Time		$T_J=150^\circ C$	59			
			$T_J=25^\circ C$	48			
$t_{d(off)}$	Turn off Delay Time		$T_J=150^\circ C$	49			
			$T_J=25^\circ C$	192			
$t_f$	Fall Time		$T_J=150^\circ C$	211			
			$T_J=25^\circ C$	37.5			
$E_{on}$	Turn on Energy		$T_J=25^\circ C$	1.23			mJ
		$T_J=150^\circ C$	1.28				
$E_{off}$	Turn off Energy	$T_J=25^\circ C$	0.46				
		$T_J=150^\circ C$	0.53				
$E_{ts}$	Total Energy	$T_J=25^\circ C$	1.69				
		$T_J=150^\circ C$	1.81				
$C_{ies}$	Input Capacitance	$V_{CE}=30V, V_{GE}=0V, f=1MHz$		4286		pF	
$C_{oes}$	output Capacitance			102			
$C_{res}$	Reverse Transfer Capacitance			68			

Anti-Parallel Diode

**Electrical Characteristic (at TC = 25 °C, unless otherwise specified)**

Symbol	Parameter/Test Conditions		Min.	Typ.	Max.	Unit
$V_F$	Forward Voltage	$I_F=20A, V_{GE}=0V, T_J=25^\circ C$		1.75	2.6	V
$t_{rr}$	Reverse Recovery Time	$I_F=15A$		45.7		ns
$I_{RRM}$	Max. Reverse Recovery Current	$di_F/dt=100A/\mu s$		2.0		A
$Q_{RR}$	Reverse Recovery Charge	$T_C=25^\circ C$		46.8		nC

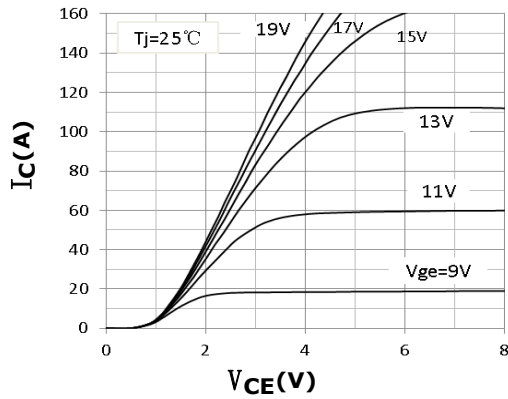

Figure 1. Output Characteristics

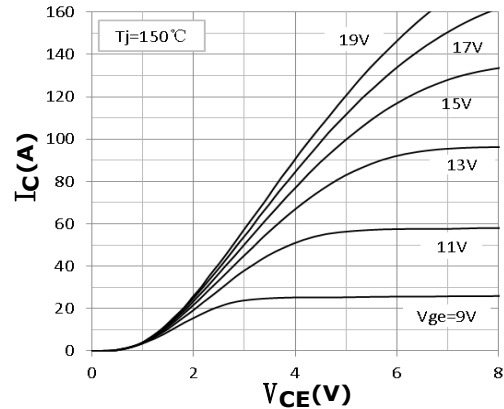

Figure 2. Output Characteristics

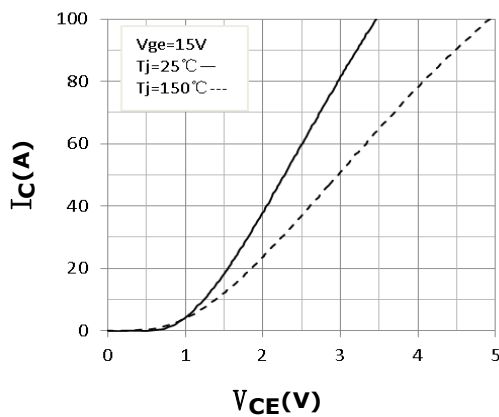

Figure 3. Saturation Voltage Characteristics

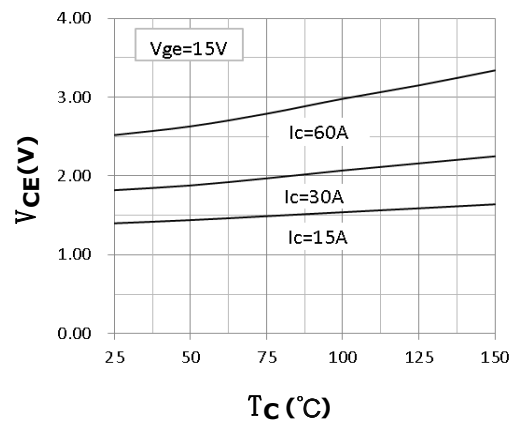

Figure 4. Saturation Voltage - TC Characteristics

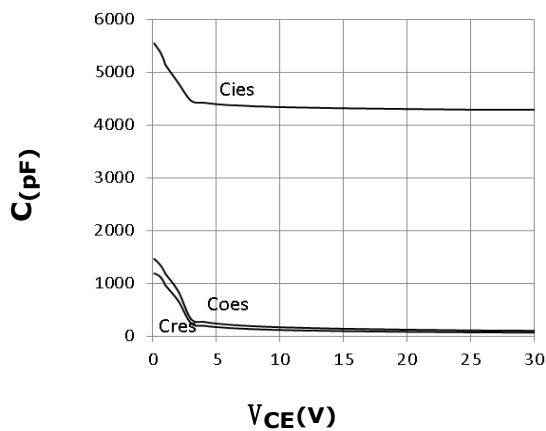

Figure 5. Capacitance Characteristics

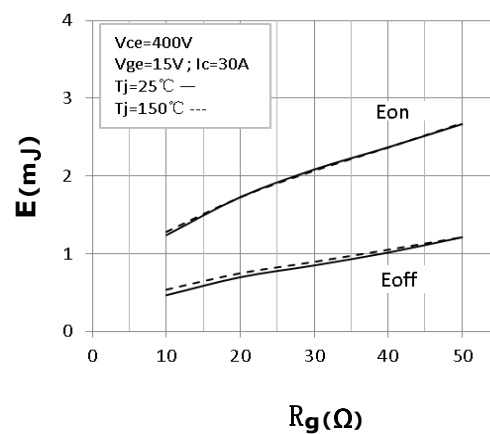

Figure 6. Switching Loss- $R_g$  Characteristics

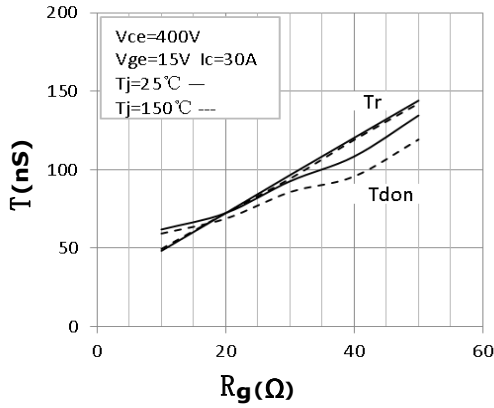

Figure 7. Opening Time-RG Characteristics

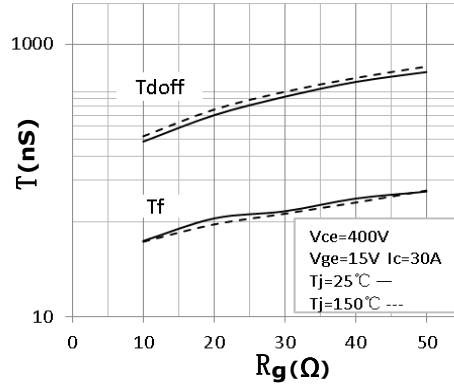

Figure 8. Closing Time-RG Characteristics

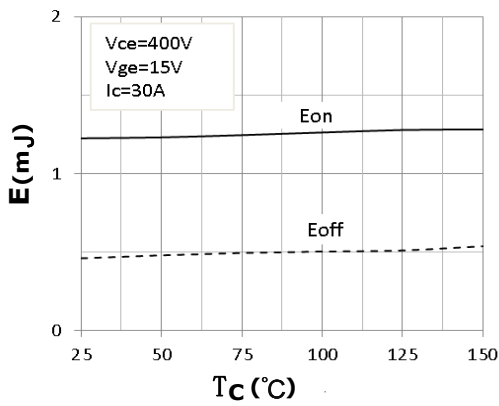

Figure 9. Switching loss-Tc Characteristics

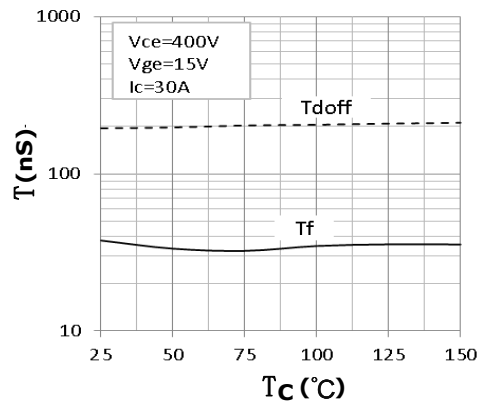

Figure 10. Closing Time-Tc Characteristics

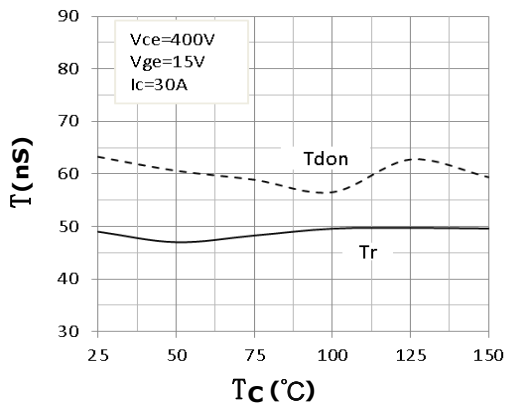

Figure 11. Opening Time-Tc Characteristics

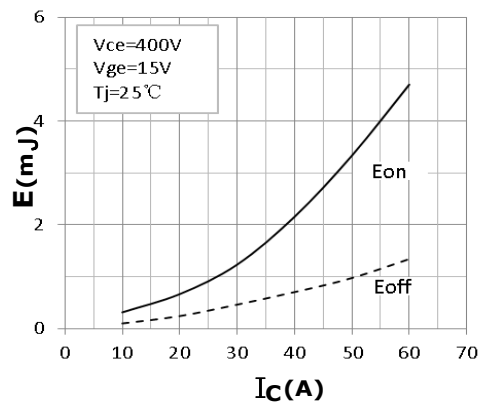

Figure 12. Switching Loss-IC Characteristics

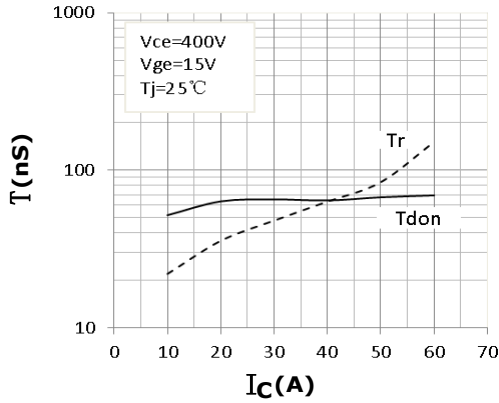

Figure 13. Opening Time-Ic Characteristics

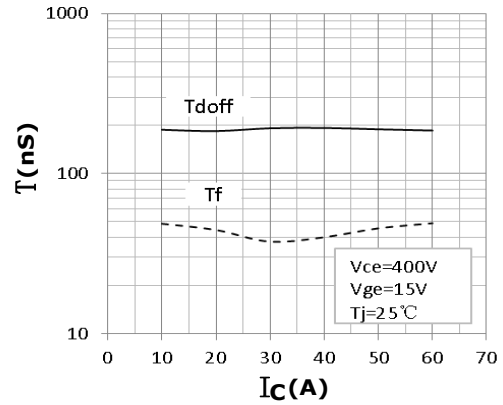

Figure 14. Closing Time-Ic Characteristics

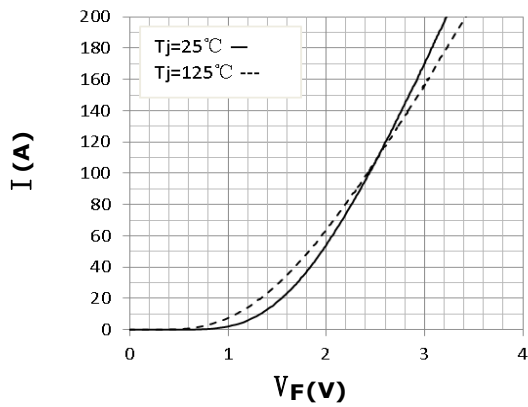

Figure 15. Diode Forward Characteristics

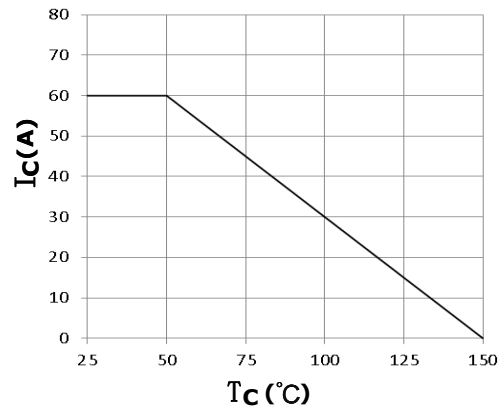

Figure 16. Collector Current-Tc Characteristics

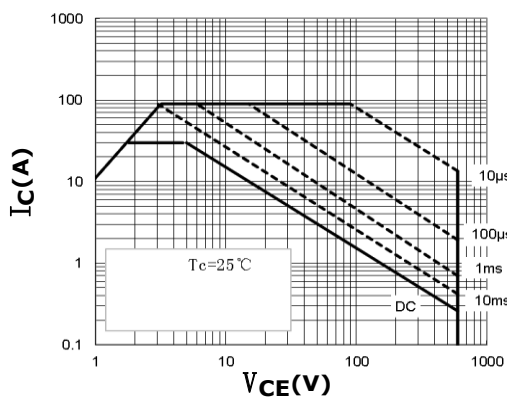

Figure 17. Forward Bias Safe Operating Area

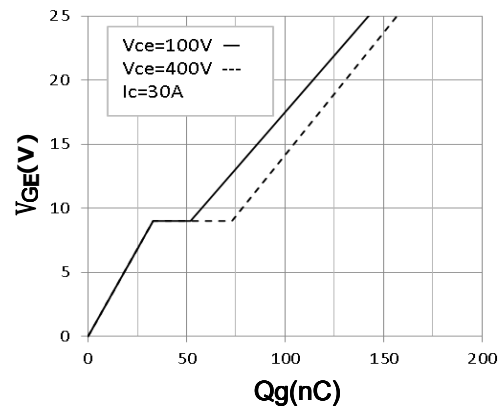

Figure 18. Gage Charge Characteristics

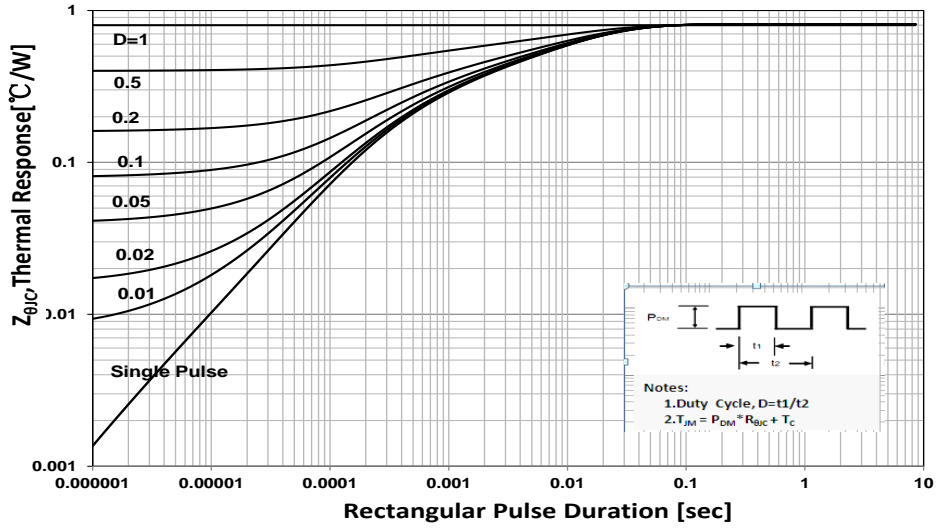
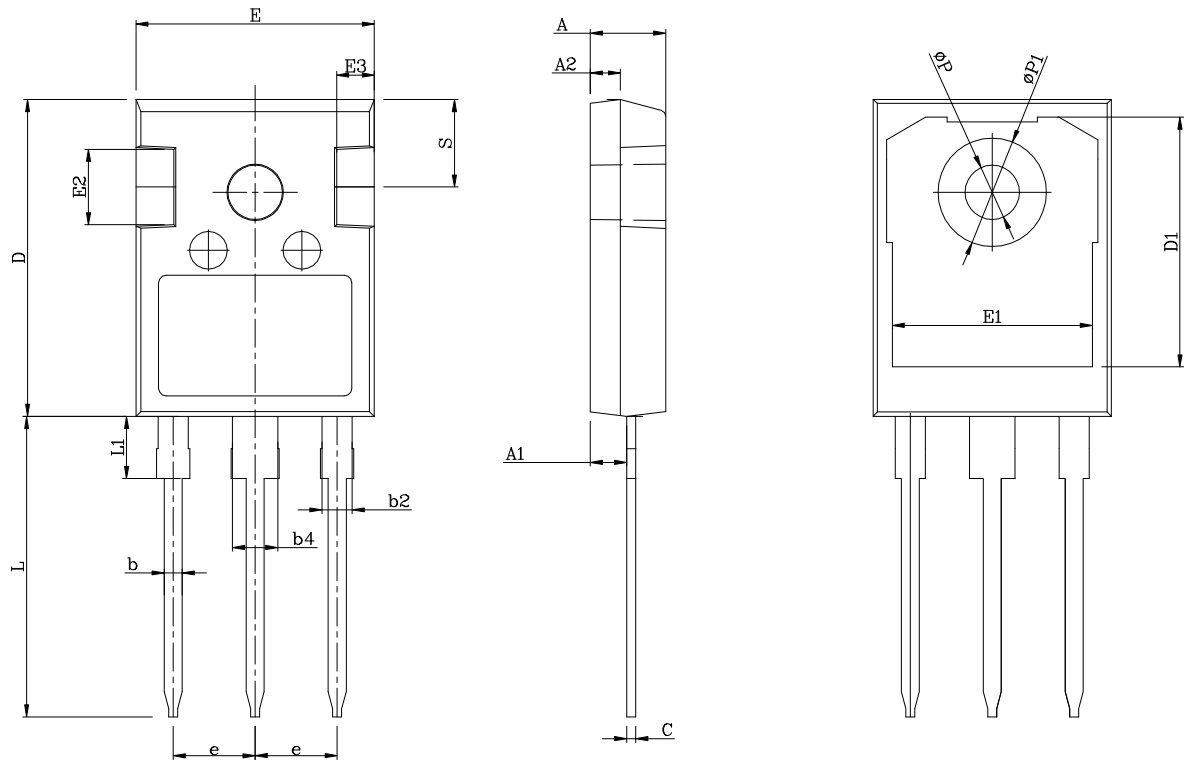

Figure 19. Transient Thermal Impedance

**TO-247-3L**



**COMMON DIMENSIONS**

SYMBOL	mm			SYMBOL	mm		
	Min	Nom	Max		Min	Nom	Max
A	4.80	5.00	5.20	E1	13.00	13.26	13.56
A1	2.23	2.41	2.59	E2	4.80	5.00	5.20
A2	1.85	2.00	2.15	E3	2.30	2.50	2.70
b	1.11	1.21	1.36	e	5.44BSC		
b2	1.91	2.01	2.21	L	19.82	19.92	20.22
b4	2.91	3.01	3.21	L1	3.94	4.12	4.30
c	0.51	0.61	0.75	ØP	3.40	3.60	3.80
D	20.80	21.00	21.30	ØP1	7.08	7.19	7.30
D1	16.25	16.55	16.85	S	6.15BSC		
E	15.50	15.80	16.10				